

**LAND -  
- ROVER**

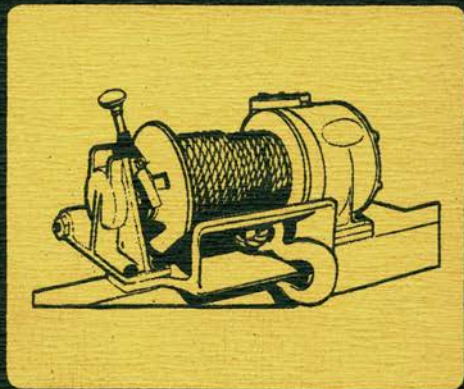

# PROPRIETARY EQUIPMENT AND SPECIAL CONVERSIONS

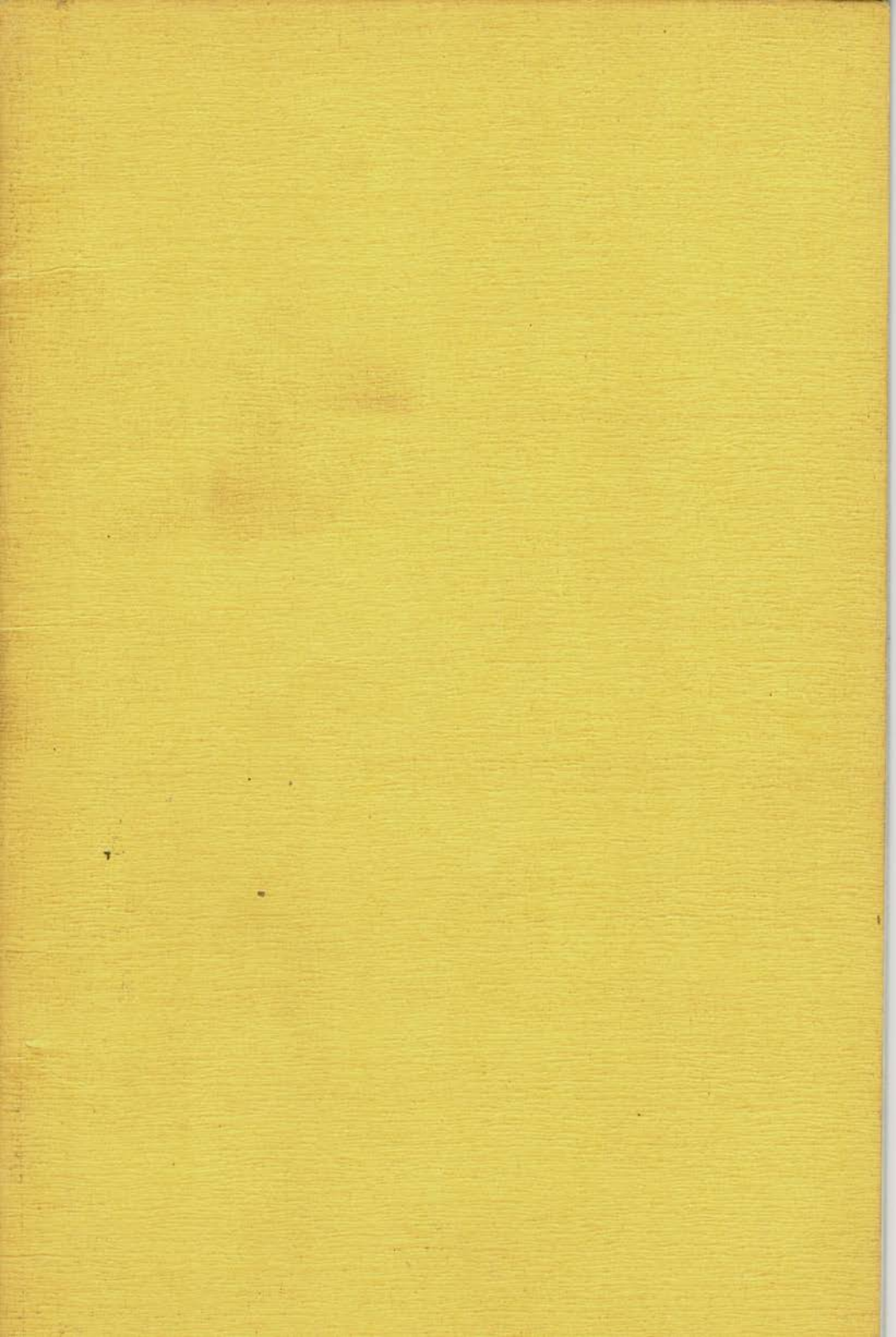



The ability of the Land-Rover to perform a very wide variety of duties is now well known.

The specifications of the items included in this booklet have been closely examined, and where considered appropriate their performance tested by the Land-Rover Special Projects Section, Engineering Department.

Except where otherwise stated, the equipment is not of Rover manufacture and the Company is in no way responsible for Sales (including recommended prices, Shipping, Delivery, etc.), Service or Warranty Claims. All matters concerning

these aspects should be taken up direct with the equipment manufacturer or his agent.

**Further information concerning this equipment is available from the companies whose addresses are listed in this booklet.**

When specialised installation services are available for certain items they have been indicated. Such services are not necessarily exclusive.

In cases of difficulty the Technical Sales Department of The Rover Company Limited are available to offer advice.

| Section  | Page |
|--|------|
| 1. Accessories .. .. .                                   | 2    |
| 2. Agricultural Implements .. .. .                       | 4    |
| 3. Air Compressors .. .. .                               | 5    |
| 4. Electrical Equipment .. .. .                          | 6    |
| 5. Emergency Units ( <i>fire, crash/rescue</i> ) .. .. . | 8    |
| 6. Lifts and Loaders .. .. .                             | 9    |
| 7. Personnel Carriers, Campers .. .. .                   | 11   |
| 8. Road Services ( <i>Municipal</i> ) .. .. .            | 12   |
| 9. Trailers .. .. .                                      | 13   |
| 10. Winches .. .. .                                      | 14   |
| 11. Miscellaneous Conversions .. .. .                    | 17   |

# 1 Accessories

These are items for fitting to the Land-Rover to increase comfort, safety and convenience in appropriate circumstances.

## **Air Conditioning**

*2.25 litre petrol models (except Forward Control)*

An engine driven installation providing a supply of cooled, dry air through dash-mounted, adjustable outlet louvres. Three levels of temperature reduction can be obtained by push-button selection. The V-belt driven compressor unit fits neatly into the engine bay, and does not interfere with any of the normal engine maintenance operations.

Full details from: Normalair-Garrett Ltd., Yeovil, Somerset.  
Telephone: Yeovil 5222.

Installation Service: Martin Walter Ltd., Cheriton Road, Folkestone.  
Telephone: Folkestone 53103.

## **Engine Speed Governor**

*2.25 and 2.6 litre petrol engines (standard fitting on diesel engines)*

A device for controlling engine speed within close tolerances when engine driven accessories are fitted. The governor is engaged by means of a hand control fitted to the dashboard. The governor can be overridden by the accelerator at any time and does not affect normal road usage in any way.

Full details from:  
(2.25 litre petrol engines)  
The Rover Company Ltd., Solihull,  
Warwickshire.  
Telephone: 021-743 4242.

(2.6 litre petrol engines)  
Tooley Electro Mechanical Co. Ltd.,  
Church Street, Earl Shilton,  
Leicestershire.  
Telephone: Earl Shilton 2091/2.

Installation Service: Supplied and fitted to NEW four cylinder petrol engined vehicles ONLY by:

The Rover Company Ltd.

All other vehicles:

Tooley Electro Mechanical Co. Ltd.

## **Road Speed Limiter**

*2.25 litre petrol models*

A device for limiting the road speed of the Land-Rover to a fixed speed, independent of gear ratio. This system will limit the vehicle to a pre-determined speed by means of a centrifugal switch and solenoid, and interchangeable, colour-coded control springs. It is not intended to control engine speed, except in so far as the relationship existing between engine speed and road speed, and it exercises no control whatsoever when the vehicle is parked and the power take-off is in operation.

Full details from: Iso-Speedic Ltd., Charles Street, Warwick.  
Telephone: Warwick 42534.

## **Trailer Power Brake Systems (Vacuum)**

*All models*

A braking system for use when towing trailers and caravans fitted with single line, vacuum braking systems. This unit utilises vacuum from the inlet manifold, or a vacuum pump on diesel models, a reserve tank, and a special control valve that ensures that the power applied to the trailer brake is in the correct proportion to the effort applied to the foot brake. A three line vacuum system—to meet U.K. Regulations—is available for trailers weighing over 2 tons gross.

Full details from: Feeney & Johnson Ltd., 134-136 Ealing Road, Wembley, Middx. Telephone: Wembley 4801/2.

## **(Compressed Air)**

### *All models*

This braking system is designed to meet current U.K. regulations for heavy trailers used with Land-Rovers. The trailer brakes are brought into operation by use of the Land-Rover handbrake or footbrake. In addition the trailer brakes are applied should the trailer accidentally become uncoupled or the brake pipes cut.

Pressure gauges and a warning buzzer are provided to tell the driver when the air pressure has dropped below the minimum safety level. Air pressure is supplied by means of a 6 c.f.m. compressor driven by belt from the engine crankshaft.

Full details from: B. Dixon-Bate Ltd.,  
Bridge Works, Tarvin, Chester.  
Telephone: Chester 24034.

### Installation Service:

Spencer, Abbott & Co. Ltd.,  
Tyburn Road, Birmingham 24.  
Telephone: 021-327 2711-6.

## **Hollow Rubber Springs**

### *All models (except Forward Control)*

A hollow rubber spring replaces the rear axle bump rubber and assists the leaf spring suspension by supporting part of the vehicle weight. On a laden vehicle, ride and appearance are improved, and sideways roll is reduced.

These springs are recommended for use where the Land-Rover regularly carries more than 50% of its payload, and/or where the centre of gravity of the vehicle is unavoidably high.

Full details from: Aeon Products Ltd.,  
11 Northdown Street, London N.1.  
Telephone: 01-837 9875.

## **Suspension Seat**

### *All models*

To replace the driver's seat only, or

both the driver's and passenger's seats. There is a matching cover for the centre seat. The Bostrom 'Saxon Thinline' seat features an in-built Girling shock absorber mounted between balanced springs, to reduce vibration and shock to a minimum. The moulded seat and back cushions are foam filled and shaped to give maximum comfort with bucket styling to give lateral support. Easy to operate on slide rails, full fore and aft adjustment is provided.

The matching covers are in the same hard-wearing trim, and with the same shaping to give a smart overall appearance, while access to the tool locker and auxiliary petrol tank (when fitted) is not affected.

Full details from: Bostrom Mfg. Co. Ltd.,  
Weedon Road, Industrial Estate,  
Northampton.

Telephone: Northampton 51332.

## **Freewheeling Front Hubs**

### *All models (except 1 ton and Forward Control)*

The purpose and function of these hubs is that of reducing the rolling resistance of the vehicle when four-wheel drive is not required. They isolate the front wheels from their drive shafts and the transmission, both in forward and reverse direction.

Full details from: Mayflower Automotive Products Ltd., Hamilton Works, Plymouth Road, Tavistock, Devon.

Telephone: Tavistock 2345.

## **Ground Anchors**

### *All models*

For use in conjunction with a winch. See Section 10.

## Agricultural 2 Implements

Compared with a tractor the Land-Rover's suspension gives it high ground speed advantages, but curtails the use of a 3 point linkage and creep speeds enough to make their provision not worthwhile. Power take-offs are available as options, being mechanically operated full torque units of the ground speed type, driven through the gearbox. The rear power take-off rotates clockwise, viewed from the rear of the vehicle, and terminates with a standard B.S.S. 6 spline shaft, 1.373 in. dia.

Drawbar pulls up to a maximum of 4,000 lb. (1820 kgs.) are available depending on vehicle model and ground surface.

The following is an example of agricultural equipment particularly suitable for the Land-Rover.

### Field Sprayers and Liquid pumps

#### *All models*

A range of field, verge and kerb

sprayers for the application of weed-killers and other chemicals, by farmers, contractors, River Boards, Park and other authorities. The sprayers are each completely self-contained units, one or two man operated and easily detached from the vehicle.

Driven from the centre or rear power take-off, each unit has its own tank, control valves, filters, and spray boom or cone nozzles, the spray booms swinging up for road work. Some models are suitable for the application of liquid fertilizers.

Full details and installation service from Evers & Wall Ltd., Lambourn Woodlands, Newbury, Berkshire.  
Telephone: Lambourn 444.

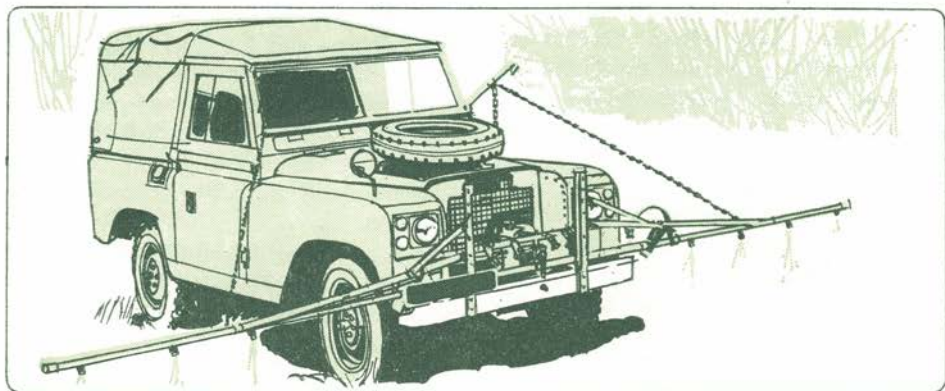



These may be required for operating a wide range of compressed air equipment and tools. Standardisation is difficult due to the variety of requirements. The following are popular examples:

### **Rotary 100 cfm.**

#### *109 in. diesel models*

The BroomWade WR 100 compressor is fitted below the floor at the rear of the vehicle leaving the load carrying area unimpeded. Driven from the centre power take-off the compressor has an output of

100 cfm free air delivery at 95 lb/in<sup>2</sup>, which is sufficient to operate two medium concrete breakers. With unimpeded load carrying space, and four-wheel drive, the Land-Rover with this conversion is ideal for use on sites normally inaccessible to the conventional two-wheel drive vehicle.

*This is supplied as a complete installation on a new Land-Rover only.*

### **Reciprocating 14 cfm.**

#### *All models (except Forward Control)*

A compressor with a delivery of 14 cfm free air at up to 150 lb/in<sup>2</sup> is mounted in the driving compartment in place of the centre seat and is driven through vee belts from the centre power take-off. This conversion is suitable for many purposes including tyre inflation, bead breaking and nut running.

Full details on the above, other sizes and installation service from: Air Drive Ltd., High Wycombe, Buckinghamshire.  
Telephone: High Wycombe 30021.

## Electrical 4 Equipment

There are many types of electrical equipment suitable for installation in the Land-Rover to provide electrical generation, welding and mobile workshop services. Standardisation is difficult due to the wide range of requirements. The following are popular examples:



### Generators

#### *All models*

Generator installations up to 25 kVA with outputs of 240 volts, 110 volts or any standard voltage, single or three phase frequencies of 50, 60, 200 or 400 c/s are available to meet the need for compact, efficient and reliable self propelled power plant. Drive to the generator is from the centre power take-off and the generators are mounted either beneath the nearside passenger seat (up to 5 kVA output) or in the rear body of the vehicle (above 5 kVA).

### Welding Generators

#### *All models*

Welding generators are available with outputs of 300 amps and 400 amps direct current driven from the centre power take-off and mounted in the rear of the

Land-Rover (in a similar manner to the generator types).

Full details from:  
Tooley Electro Mechanical Co. Ltd.,  
Church Street, Earl Shilton,  
Leicestershire.  
Telephone: Earl Shilton 2091.

#### *All models (except Forward Control)*

A welding generator rated at 250 amps, 400 c/s, driven from the centre power take-off and mounted in the cab of the Land-Rover (replacing the centre seat) and suitable for use with up to 4 gauge (6 mm.) rod.

Full details from: Hayters (Sales) Ltd.,  
Spellbrook, Bishop's Stortford, Herts.  
Telephone: Sawbridgeworth 3444.

#### Installation Service:

Tooley Electro Mechanical Co. Ltd.,  
Church Street, Earl Shilton,  
Leicestershire.  
Telephone: Earl Shilton 2091.



#### *All models (except Forward Control)*

150 and 200 amp direct current units driven directly from the rear power



take-off by a belt drive mounted on a subframe which can be quickly fitted in place of the vehicle's tailboard.

Full details from: Lincoln Electric Co. Ltd., Welwyn Garden City, Hertfordshire.

Telephone: Welwyn Garden 24581.

### Workshops

*All models*

Designed to provide a compact, go-anywhere mobile workshop, these installations incorporate generator, welder and

air-compressor units providing power for drills, cutting saws, grinders, lighting units and other power tools contained within a workshop vehicle fitted with work benches, tool lockers, bench vice and protective canopy. The workshops can contain any of the generator types outlined above.

Full details and installation service from: Tooley Electro Mechanical Co. Ltd., Church Street, Earl Shilton, Leicestershire.

Telephone: Earl Shilton 2091.

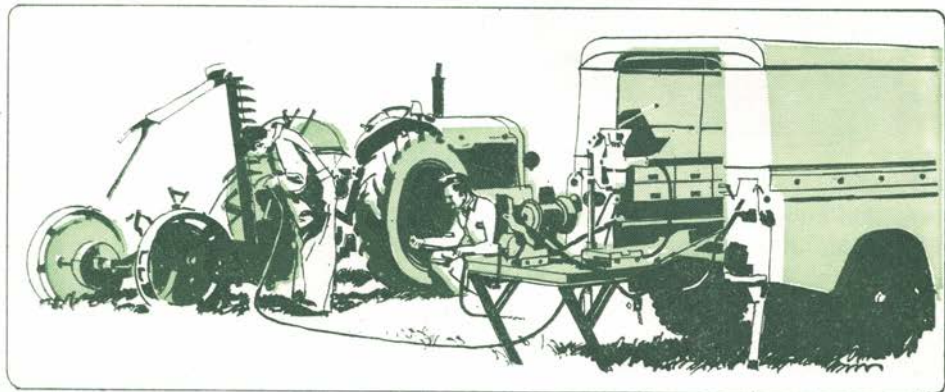

## Emergency 5 Units

There are several firms building specialised units to deal with fire, and rescue work. A recent addition has been the development of units specially designed for traffic crash/rescue work.

### Fire Tenders and Crash Vehicles



#### *All models*

A wide range of fire tenders based on the 88 in., 109 in., and 110 in. F.C. Land-Rover chassis, with in-built or portable fire pumps for water, fog, foam, CO<sub>2</sub> and vaporising liquids; hose reels, tanks, ladders and equipment lockers; generators for lighting and cutting tools.

These light and compact fire appliances are ideal for municipal, industrial and

airfield use. Appliances built and fitted to customer specification.

Full details from: Carmichael & Sons (Worcester) Ltd., Gregory's Mill Street, Worcester.

Telephone: Worcester 21383.

H.C.B. Angus Ltd., Totton, Southampton.

Telephone: Totton 3641.

Pyrene Company Ltd.,  
9 Grosvenor Gardens, London S.W.1.  
Telephone: Victoria 8474.

### Ambulances and Dispensaries

*All models (except Forward Control)*

A large range of conversions, from complete bodies to adaptations of the production Land-Rover bodywork. A variety of interior layouts and equipment on new vehicles is available to customer requirements.

Full details from: Herbert Lomas Ltd., Handforth, Wilmslow, Cheshire.

Telephone: Wilmslow 5258.

Pilchers (Merton) Ltd., Victoria Road, Burgess Hill, Sussex.

Telephone: Burgess Hill 5707.

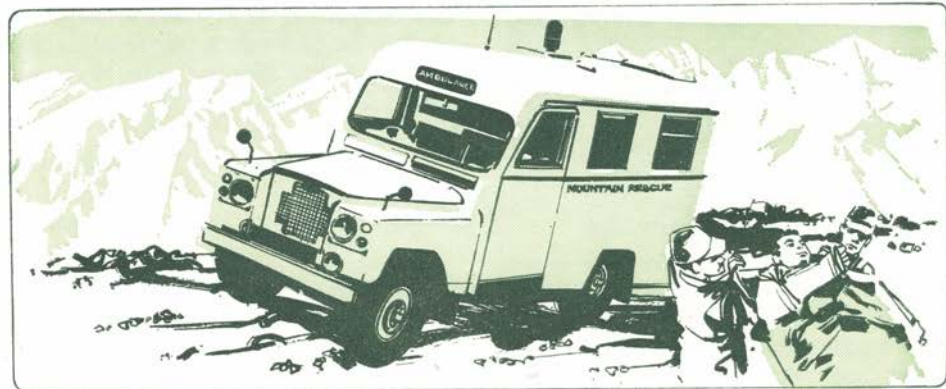

## Light Vehicle Recovery Equipment

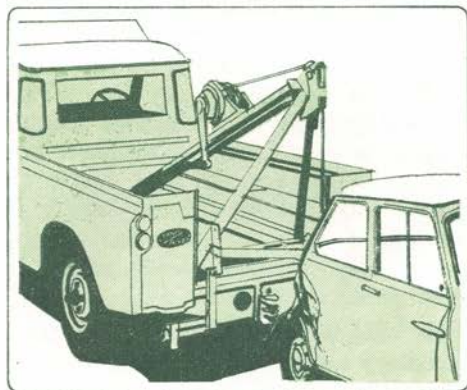

### *All models*

A lightweight pick-up crane for mounting in the rear body of normal control Land-Rovers. Detachable, and with a range of optional equipment available, such as towing ambulance and sling.

An ideal crane for recovering cars and

light vans, with built-in anti-sway bar and swivelling head for side pulls.

Full details from: Harvey Frost & Co. Ltd., Dunow Road, Bishop's Stortford, Hertfordshire.

Telephone: Bishop's Stortford 3208.

## Aircraft Baggage Loader

*88 in. and 109 in. models*

A specialised conversion of the Land-Rover, with a centre mounted, 3 section, continuous belt conveyor system. Each section can be elevated by means of an hydraulic ram. All controls for conveyor direction, elevation and depression of all boom sections are hydraulic, and are placed adjacent to the driver.

Bodywork, seating and steering layout are altered to allow the low level mounting of the conveyor.

Full details from: H. W. Edghill Equipment Co. Ltd., Hook, Nr. Basingstoke, Hampshire. Telephone: Hook 2121.

### Hydraulic Platforms

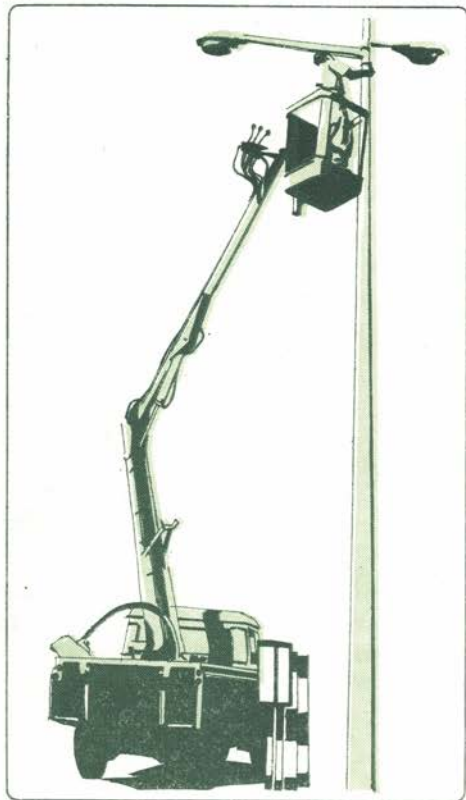

#### 109 in. and Forward Control

A range of elevating hydraulic plat-

forms capable of rotating to either side of the vehicle. Spring lock-out jacks are fitted to eliminate the need for stabilising out-riggers, and working heights from 28 ft. can be reached by the 109 in. mounted models. A model with working heights of up to 33 ft. is available on the 110 in. F.C. The operator can control all movements through simple controls in the working cage. This installation being particularly compact, creates minimum obstruction to traffic flow.

Full details from: Simon Engineering (Dudley) Ltd., Queens Cross, Dudley, Worcestershire.

Telephone: Dudley 54661.

#### All models

A fixed base lift developed to fulfil a need for a reasonably priced elevating platform that does not completely monopolise the vehicle. The unit is designed to allow removal from the Land-Rover.

The platform rises to a maximum of 15 ft. making heights of 20 ft. accessible to the operator.

Full details from: Western Engineering (Delabole) Co. Ltd., Pentire Works, Delabole, Cornwall.

Telephone: Camelford 3312.

### Safari Sleeper



Based on the 88 in. Land-Rover, with hard-top and Station Wagon rear door, the Safari conversion consists of specially designed rear seating which, in combination with two modified front passenger seats, provides seating for seven, individual beds for two, or seating for three with uninterrupted cargo carrying space.

When the centre folding table is used, there is room for four around it.

Full details from: R. J. Searle Ltd.,  
Thames Street, Sunbury-on-Thames,  
Middlesex.

Telephone: 09-237 85205.

### 'Dormobile' Caravan

109 in. Station Wagons

A mobile caravan conversion of the Land-Rover.

With the patent 'Dormobile' elevating roof, the interior contains beds for four, forward facing seats for five (or six occasionally), washbasin, cooker, wardrobe, table and storage lockers. There is ample headroom, and space for four around the table.

Full details from: Dormobile Ltd.,  
Folkstone, Kent.

Telephone: 0303 76321.



## Atumat Sewer and Drain Cleaner



### *All models (except Forward Control)*

A method of sewer and drain cleaning whereby water at about 900 lb/in<sup>2</sup> is pumped through the high pressure hose to a special nozzle with backward facing jets. The thrust from this nozzle carries the hose forward, and cleaning takes place when the hose is winched back. Using the Hand Gun, the unit can also be used for specialised cleaning duties.

Full details from: Metering Pumps Ltd., 49 Uxbridge Road, Ealing Broadway, London W.5.

Telephone: Ealing 6264.

## Snow and Earth Clearance

### *All models (except Forward Control)*

Straight type, front mounted blades,

raised and lowered manually or by hydraulic ram, controlled either by hand-operated hydraulic pump or by an electro-hydraulic power pack placed in the cab within easy reach of the driver. The bulldozer blade with a swept width of 57 in., can be angled to right or left at 25°, the snowplough at 30°. The blades are shaped to give good rolling action to soil or snow.

Full details from: Atkinsons of Clitheroe Ltd., Kendal Street, Clitheroe, Lancashire.

Telephone: Clitheroe 2211.



A 'V' type snowplough for use at speeds of up to 25 m.p.h. Easily fitted or removed from the Land-Rover with no structural alterations. Raised and lowered mechanically.

Full details from: J. A. Cuthbertsons Ltd., Biggar, Scotland.  
Telephone: Biggar 20.

There are many trailers suitable for towing by the Land-Rover provided the following weight limitations are observed; Cross country, 1 ton (1020 kg.) gross, for trailer plus load.

Road and track using overrun brakes, 2 tons (2040 kg.) gross, for trailer plus load.

Road only; trailers with 4 wheels (not close coupled) and independent power operated brakes, 3 tons (3060 kg.) gross, for trailer plus load (diesel Land-Rover). 4 tons (4080 kg.) gross, for trailer plus load (petrol Land-Rover).

Below are given brief details of trailers specially made for the Land-Rover.

#### Articulated Trailer

88 in. chassis/cab

A versatile, lightweight, articulated vehicle, equally at home on or off the road. A wide range of semi-trailer designs are available for every purpose, and also a detachable pick-up body, quickly and simply attached to the Land-Rover, for when the trailer is not in use.

Full details from: B. Dixon-Bate Limited, Bridge Works, Tarvin, Chester.

Telephone: Chester 24034.

#### Powered-Axle Trailer

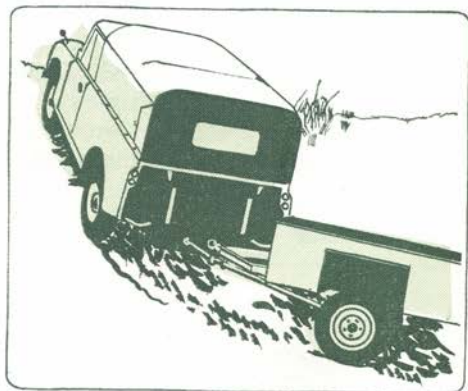

#### 109 in. models

A 1 ton capacity cargo or tanker trailer, powered by propeller shaft from the Land-Rover, which uses an extra transfer gearbox driven from the transmission. Thus six wheel drive is obtained, giving exceptional cross-country performance.

Full details and installation service from: Scottorn Limited, Victor Works, Kingston Road, New Malden, Surrey. Telephone: Malden 3633.

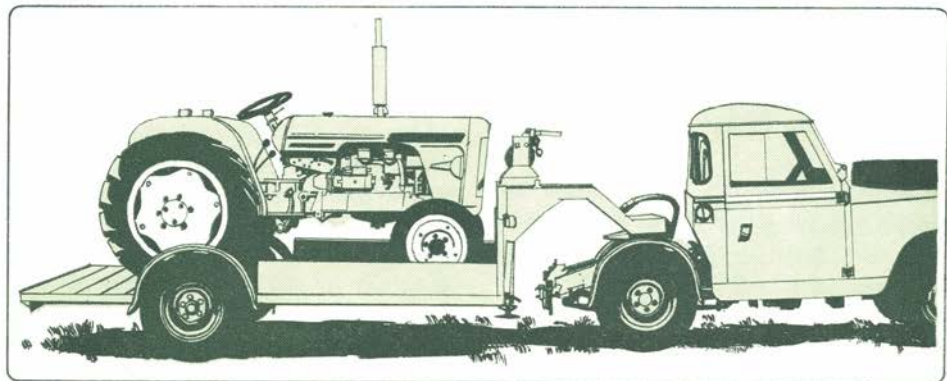

## 10 Winches

There are many winches available for fitting to the Land-Rover and, excluding manually powered units, they can be classified under three categories:— Capstan, Drum, Special Purpose, all with front pulls unless otherwise stated.

Note that a specialist installation service is available for all the winches described.

### Capstan Winch

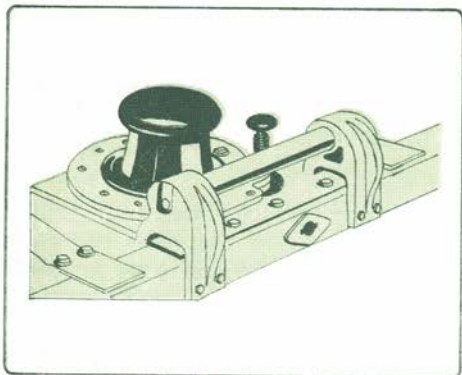

*All models (except Forward Control)*

This is probably the simplest form of mechanically actuated pulling aid. When a suitable rope is tightly coiled two or three times round the revolving capstan the friction generated is sufficient to give pulls of up to 2,500 lbs. from the Land-Rover. A useful aid in self recovery when surface conditions overcome the traction of four wheel drive. A more powerful unit (hydraulically driven) is available for underground cable removing, mole ploughing, etc.

#### *Mechanical Drive*

Full details from:

Aeroparts Engineering Co. Ltd.,

Commercial Road, Hereford.

Telephone: Hereford 3068.

Installation Service:

Supplied and fitted to new four cylinder

engined vehicles only.

The Rover Company Ltd., Solihull, Warwickshire. Telephone: 021-743 4242.

Six cylinder engined vehicles.

Spencer, Abbott and Co. Ltd.

Tyburn Road, Birmingham 24.

Telephone: 327 2711-6.

#### *Hydraulic Drive*

Full details from: Turner Mfg. Co. Ltd.,

Fordhouses, Wolverhampton.

Telephone: Fordhouses 3451.

Installation Service:

Spencer, Abbott and Co. Ltd.,

Tyburn Road, Birmingham 24.

Telephone: 327 2711-6.

### Drum Winch

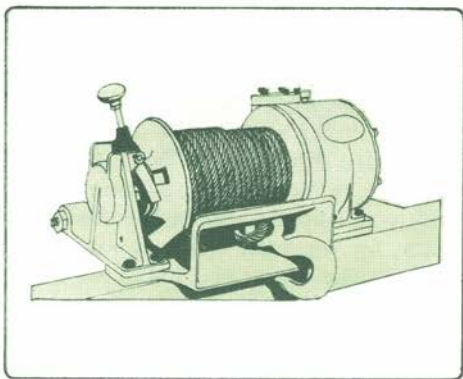

*All models (except Forward Control)*

The advantage of this type is that the winch cable (usually steel) is stored on the drum when not in use. Included is a drum release control to enable the cable to be pulled out prior to winding in under power and a clutch mechanism for engaging and disengaging the power drive. The actual transmission to the winch is generally by mechanical means. Hydraulic transmission, although tending to be costlier, offers advantages in control and safety which make it attractive for certain



duties. Pulls from 4,000 lb. upwards are available with the drum powered in one or both directions. This latter, reversible type of drum winch is also suitable for hoisting purposes but in any such applications it is most important that appropriate regulations governing lifting appliances are adhered to by the user.

*Mechanical Drive, Non-Reversible*

Full details from:  
Turner Manufacturing Co. Ltd.,  
Fordhouses, Wolverhampton.  
Telephone: Fordhouses 3451.

*Mechanical Drive, Reversible*

Mayflower Automotive Products Ltd.,  
Plymouth Road, Tavistock, Devon.  
Telephone: Tavistock 2345.

*Hydraulic Drive, Reversible*

The Rover Company Ltd.,  
Lode Lane, Solihull, Warwickshire.  
Telephone: 021-743 4242.

**Installation Service:**

Spencer, Abbott and Co. Ltd.,  
Tyburn Road, Birmingham 24.  
Telephone: 327 2711-6.

*Forward Control models only*

A drum type winch **MECHANICALLY** driven by means of a right angle drive from the centre power take-off and capable of pulls up to 7,000 lb. The drum is located alongside the left hand main chassis frame side member which enables the cable to be paid out to the front or rear of the vehicle.

Full details from:  
Norvad Equipment Ltd., P.O. Box 14,  
Passey Place, Eltham, London S.E.9.  
Telephone: 01-850 0367.

**Installation Service:**

Spencer, Abbott and Co., Tyburn Road,  
Birmingham 24. Telephone: 327 2711-6.

**Special Purpose Winch**

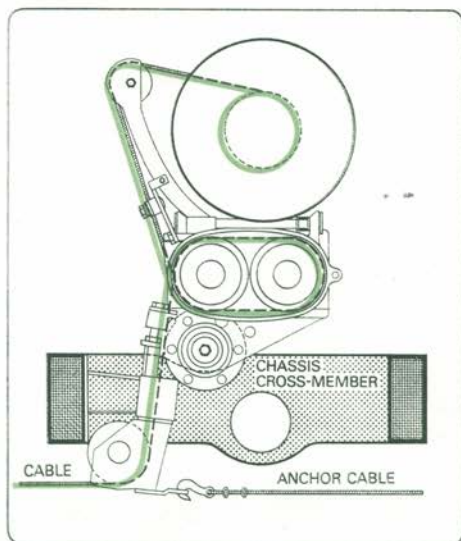

*All models*

An ability to store exceptional amounts of cable on a capstan type winch is often essential during the installation of cables and conductors, both in overhead work or in subterranean conduits, and forestry work. Winches of this type are available carrying up to 1,500 ft. of 8 mm cable and with the cable recovery point under the vehicle's centre, permitting a pull in any direction. **MECHANICALLY** driven and **REVERSIBLE**.

Full details from: Fuller, Lucas & Co. Ltd., Crowborough Cross, Eridge Road, Crowborough, Sussex.  
Telephone: 089-26 2000.

**Installation Service:**

Spencer, Abbott and Co., Tyburn Road,  
Birmingham 24. Telephone: 327 2711-6.

## Winches 10 continued

### *All models*

For installation of electrical power cables or hauling timber, a HYDRAULICALLY operated capstan has been evolved. It is mounted in a carrying frame complete with its hydraulic motor and control valve, so that it can be moved from the vehicle and anchored either in the cable trench or on the surface of the ground. The hydraulic power is provided by units from the hydraulic system of the Land-Rover drum winch, i.e. centre power take-off driven pump, tank, piping etc., terminating in two self sealing couplings located on the right side front mudwing valence. If a hydraulic drum winch is fitted to the vehicle a change over valve and self sealing couplings can be added to the circuit if desired to enable this alternative winch to be operated.

Full details from: Torkmaster Ltd., Eastern Boathouse, Burnham-on-Crouch, Essex.

Telephone: Burnham-on-Crouch 3326.

Installation Service:

Spencer, Abbott and Co. Ltd.,

Tyburn Road, Birmingham 24.

Telephone: 327 2711-6.

### *All models*

Wheel chocks which fold flat for storage. Placed under front wheels, and attached by chain to front bumper. Heavy duty bumper available.

Full details from: Mayflower Automotive Products Ltd., Plymouth Road, Tavistock, Devon.

Telephone: Tavistock 2345.

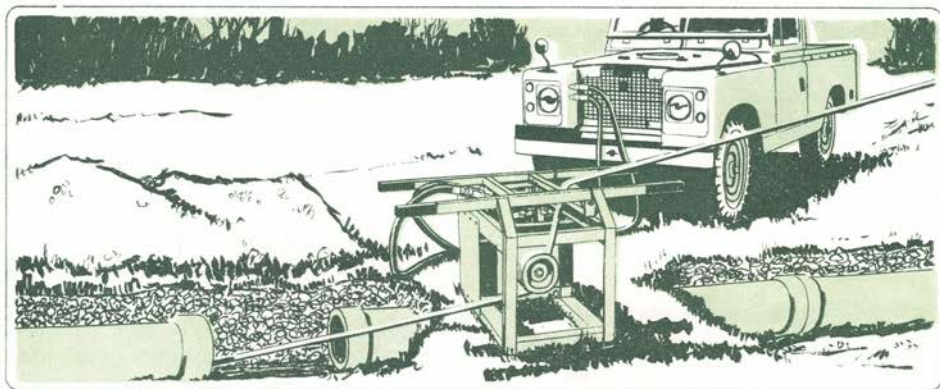

## Mobile Cinema

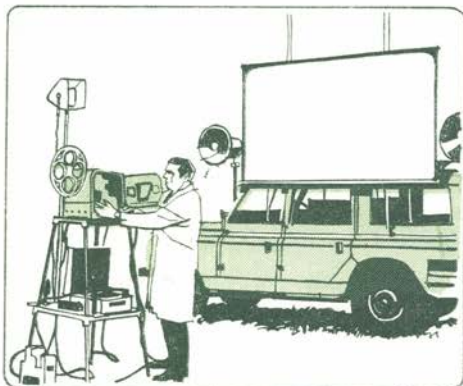

### 109 in. Station Wagons

Robust, fully tropicalised and completely self-contained Audio Visual Units. Based on the Land-Rover 109 in. Station Wagon, these mobile cinema conversions can be fitted out to customer's requirements with cinema projector, sound recording equipment, collapsible screen mounted on the vehicle's roof, and public address facilities. Power is sup-

plied by a centre power take-off driven generator.

Full details from: British Films Ltd., 260 Balham High Road, London S.W.17. Telephone: 01-672 6677.

Cintec Ltd., 1-7 Ernest Avenue, West Norwood, London S.E.27.

Telephone: Gipsy Hill 7379.

## Lubrication Equipment

### 109 in. models

A self contained lubrication set for fast and economical on-site plant servicing. The equipment includes a compressor driven by a small petrol engine, air operated grease and oil pumps, hose reels, tyre inflator, penetrating oil sprayer and utilises standard 112/130 lb. and 10 gallon oil drums. The triple hose reel units carry 25 ft. of hose and are self-retracting, and a 30 ft. air hose is supplied for tyre inflation.

Full details from: Tecalemit (Engineering) Ltd., Plymouth, Devon.

Telephone: Plymouth 62844.



## 11 Conversions continued

### Refuse Collector



#### 109 in. chassis/cab

A sturdy 3 cub. yard tipping refuse body, constructed of steel sheet on a steel subframe, with sliding hatches for loading, and a swinging tailgate for discharge. Tipping gear is hand-operated telescopic screw type, and has two winding handles.

Full details from: Hanger Engineering Ltd., P.O. Box 43, Eagle Works, Warwick.

Telephone: Warwick 42131.

### Stake Side Body



#### 109 in. chassis/cab

A flat timber platform body with stake

sides and tailboard. This conversion features removable side and rear panels, a flat, unobstructed floor, and underfloor spare wheel storage.

Full details from: P. D. Stevens & Sons Ltd., Adderley Road, Market Drayton, Shropshire.

Telephone: Market Drayton 2396.

### Shorland Armoured Car

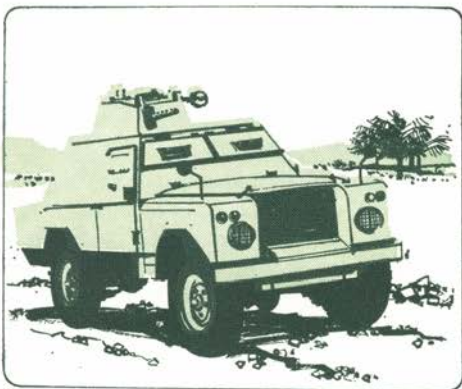

Based on the 109 in. military Land-Rover chassis, the Shorland armoured car provides an effective degree of protection against small arms fire and improvised ambush weapons. With a 360° rotation gun turret, having mountings for a .300 in. Browning or 7.62 mm. general purpose machine gun, and observation and escape hatches, the vehicle takes a crew of three, and is suitable for operation in all climates.

Full details from: Short Brothers & Harland Ltd., Queen's Island, Belfast, Northern Ireland.

Telephone: Belfast 58444.

### Mobile Workshop

See Section 4.



THE ROVER COMPANY LIMITED  
SOLIHULL · WARWICKSHIRE · ENGLAND

Whilst every effort is made, in Rover literature, to provide information that is strictly up-to-date, no responsibility can be accepted for such alterations that occur after date of going to press.

The illustrations in this booklet show possible applications for the equipment listed, and are not intended to be accurate representations of these implements.

